



IceBank[®]

THERMAL ENERGY STORAGE

DRAWING
Model 1082A
June 2009
CS-27

CALMAC Manufacturing Corp. 3-00 Banta Place Fair Lawn, NJ 07410 Tel (201) 797-1511 www.Calmac.com

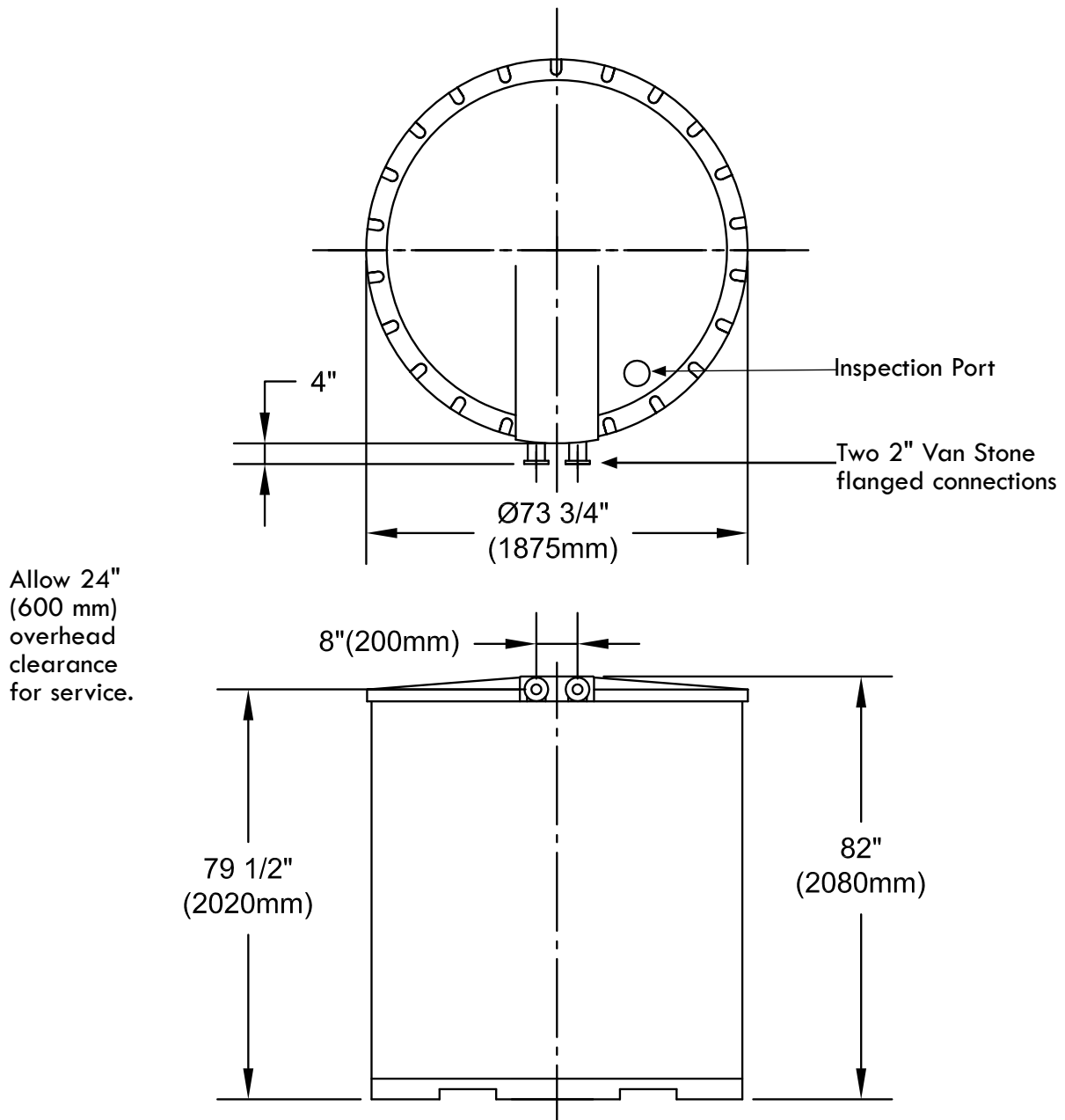

NOTE: Tolerance for all dimensions is $\pm 1/2"$ (12.5 mm)